



Ender 3 Series 3D Printer

Quick Start Guide

- ◆ This guide is for the Ender 3 Series of 3D printers.
- ◆ Select the correct input voltage to match your local mains (220V or 110V)
- ◆ Because of software/hardware upgrades and model differences, new revisions may not be listed in this guide.
- ◆ Detailed instructions for use are available on the SD card.



Notes

1. Do not use the Printer in any way other than described herein to avoid personal injury or property damage.
2. Do not place the Printer near flammables, explosives or heat sources. It is best to place it in a well-ventilated, low-dust environment.
3. Do not expose the Printer to violent vibration or any unstable environment. This will cause poor print quality.
4. The filaments recommended by the manufacturer are preferred as to avoid clogging in the hot end and/or Printer damage.
5. Do not use any other power cable than the one supplied. Use a grounded three-prong power outlet.
6. Do not touch the nozzle or hot bed during printing. Keep hands away from machine while in use to avoid burns or personal injury.
7. Do not wear gloves or loose clothing when operating the Printer. These loose articles can become caught in moving parts and cause personal injury or Printer damage.
8. Clean off filament from the nozzle tip with the provided pliers before the nozzle cools. Do not touch the nozzle directly. This can cause personal injury.
9. Clean the Printer frequently. With the machine powered off, clean the printer body with a dry cloth to remove dust, adhered printing materials and foreign objects on guide rails. Use glass cleaner or isopropyl Alcohol to clean the print surface before every print for consistent results.
10. Children under 10 years of age should not use the Printer without supervision.

Contents

1. Introduction	1	5. Software Installation	9
2. LCD Menu	2	6. Preparing to Print.....	10
3. Loading Filament	3	7. Trouble-shooting	11
4. Bed Leveling	4	8. Circuit Wiring Diagram	12

Preface

Dear consumers,

Thank you for choosing our products. For the best experience, please read the instructions before operating the Printer. Our 3D team is always ready to provide you with assistance. Please contact us via the phone number or e-mail address provided at the end when you encounter any problem with the Printer.

For a better experience in using our product, you may learn how to use the Printer in the following ways:

1. View the accompanied instructions and videos on the SD card.
2. Visit our official website at www.creality3d.cn. You will find relevant software/hardware information, contact details and operation and maintenance instructions on the website.

1. Introduction

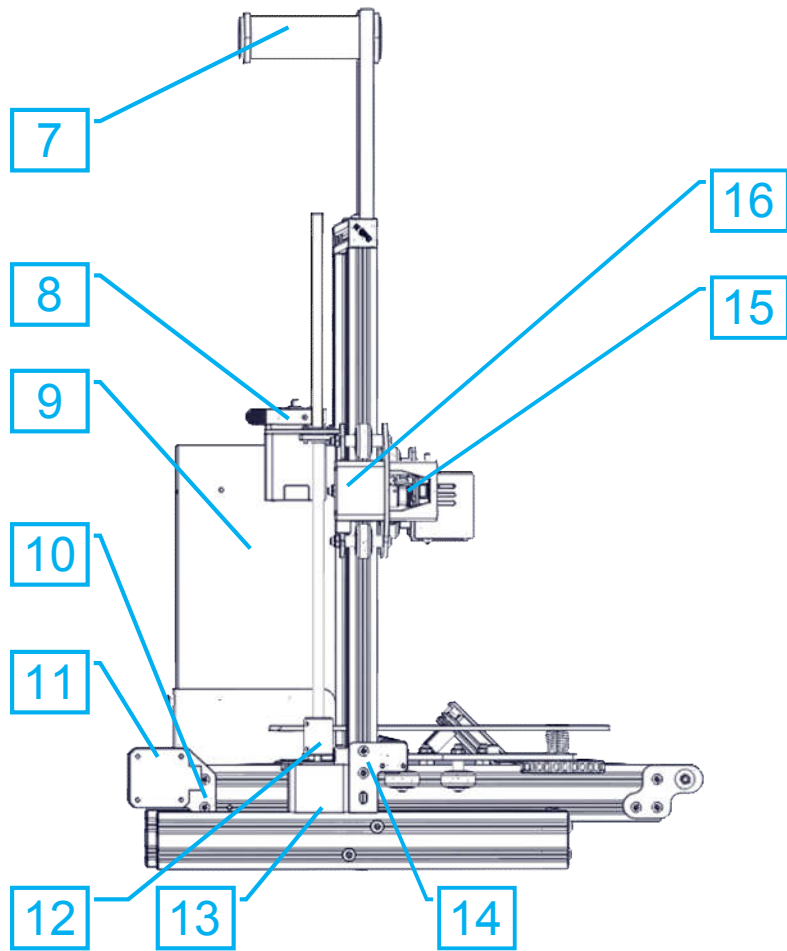
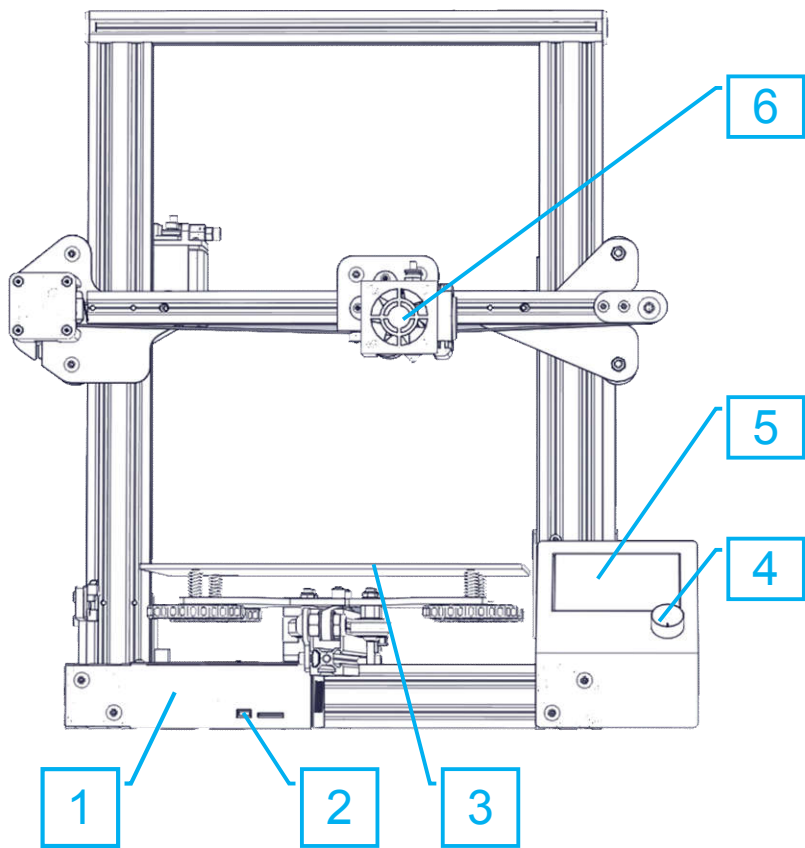

- | | | | |
|-------------------------|-------------------------|--------------------|--------------------|
| 1. Control Box | 5. Display | 9. Power | 13. Z Stepper |
| 2. SD Slot and USB Port | 6. Nozzle Assembly | 10. Y Limit Switch | 14. Z Limit Switch |
| 3. Print Surface | 7. Spool Holder | 11. Y Stepper | 15. X Limit Switch |
| 4. Control Knob | 8. Extruder (E) Stepper | 12. Coupling | 16. X Stepper |

2. LCD Menu

Information Displayed

The LCD screen displays the following information:

- Model:** Ender3
- Print speed:** 0%
- Set temperature of the Nozzle:** 230°
- Current temperature of the Nozzle:** 23°
- Set temperature of the Hot Bed:** 230°
- Current temperature of the Hot Bed:** 23°
- Part Cooling Fan Speed:** 1%
- Current location of the nozzle:** X:000.0 Y:000.0 Z:+000.0
- Print time:** 100%
- Print progress:** --:--
- Prompt message:** www.creality3d.cn

Control instructions:

- Push: OK/Enter Sub Menu
- Turn: Change Option/Value

Screen Options

Menu	Sub Menu	Explanation
↑ Info Screen ↑	↑ main ↑	Return
Prepare →	Disable Steppers	Moving X Y Z axis by your hands
	Auto Home	return to the origin
	Preheat PLA	
	Preheat ABS	
	Cooldown	Close and cooldown the nozzle
Control →	Move Axis →	Moving X Y Z axis or Extruder by given value.
	Temperature →	Heat the nozzle and the bed or change fan speed by given value
No card /Print from SD	Restore Failsafe	Restore factory setting
Init. SD-Card /Change SD-Card		Select the printing model
Printing		
Tune →	Speed	Change Printing Speed by given value
	Nozzle	Change the temperature by given value
	Bed	Change the temperature by given value
	Fan Speed	Change Fan Speed by given value
	Flow	Change filament flow by given value
Pause Print		
Stop Print		

3. Loading Filament

1. Preheat

Method 1

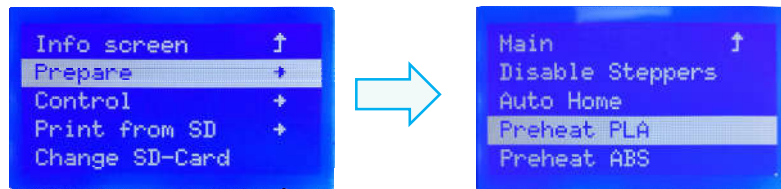

Method 2

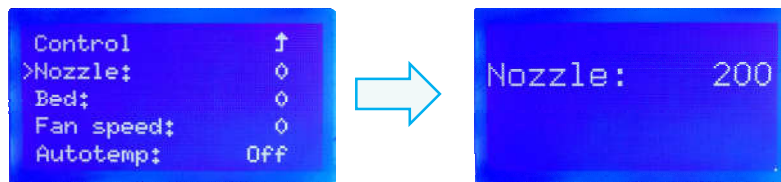
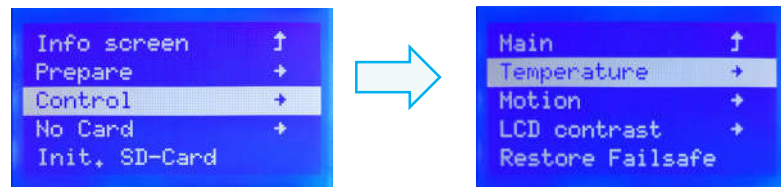

2. Feeding

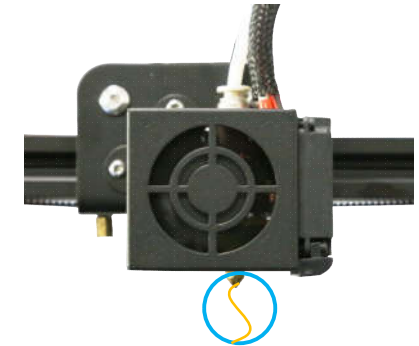
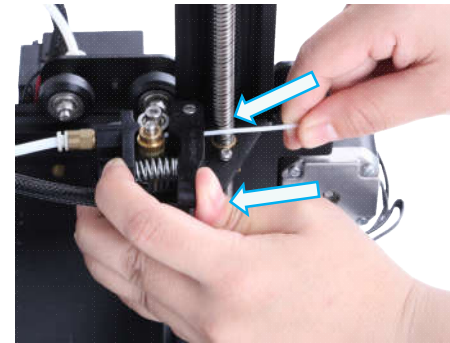

Press and hold the extruder lever then insert 1.75mm filament through the small hole of the extruder. Continue feeding until you see filament come out the nozzle.

Tip: Replacing the Filament

Preheat the nozzle then pull out the existing filament. Next, insert the new filament.

4. Bed Leveling

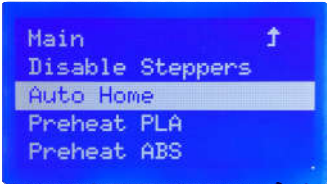
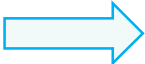
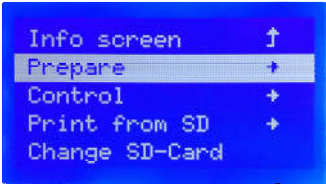

1. Prepare → Auto Home. Wait for the nozzle to move to the left/front of the platform.

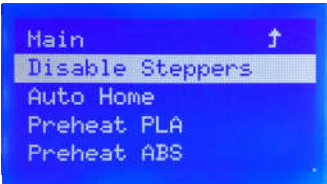
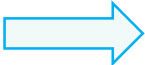
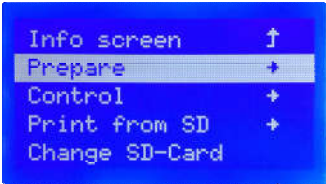

2. Prepare → Disable Steppers

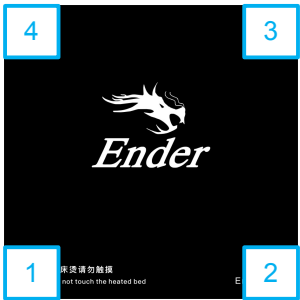
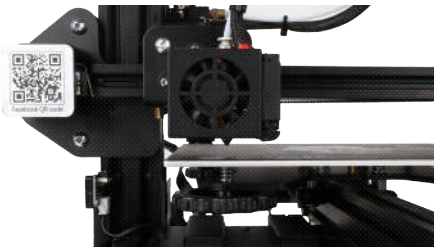

- 3. Move the nozzle the front/left leveling screw and adjust the platform height by turning the knob underneath. Use a piece of A4 paper (standard printer paper) to assist with the adjustment, making sure that the nozzle lightly scratches the paper.
- 4. Complete the adjustment on all 4 corners
- 5. Repeat above steps 1-2 times if necessary.

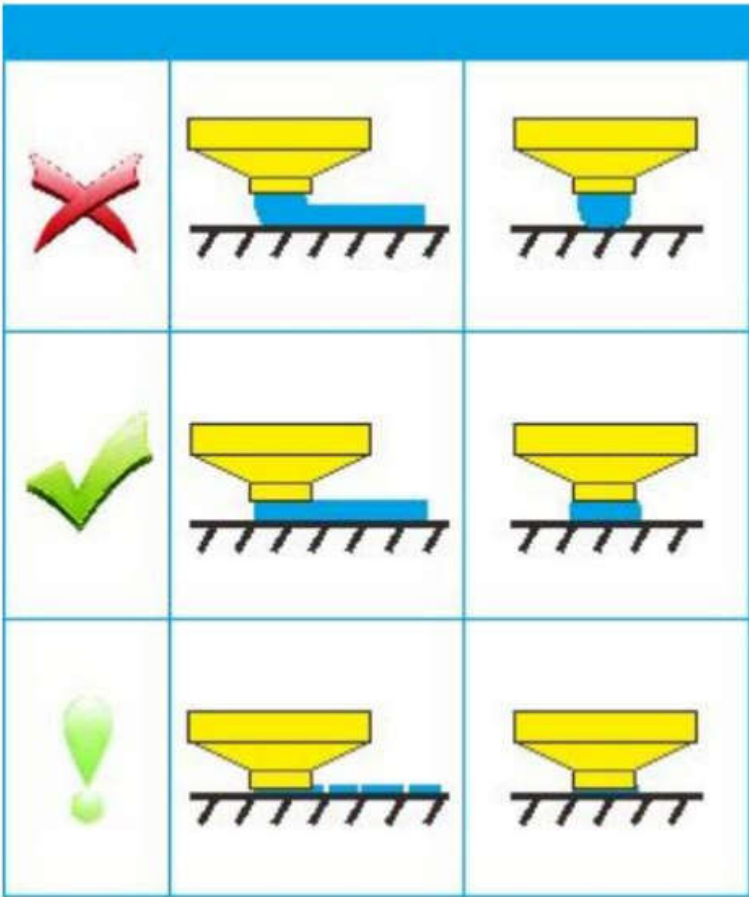

5. Software Installation



1. Double click the Cura icon to install the Cura Slicing Software.

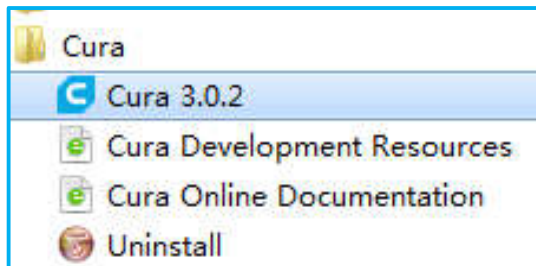

2. Start Cura from the Start Menu.

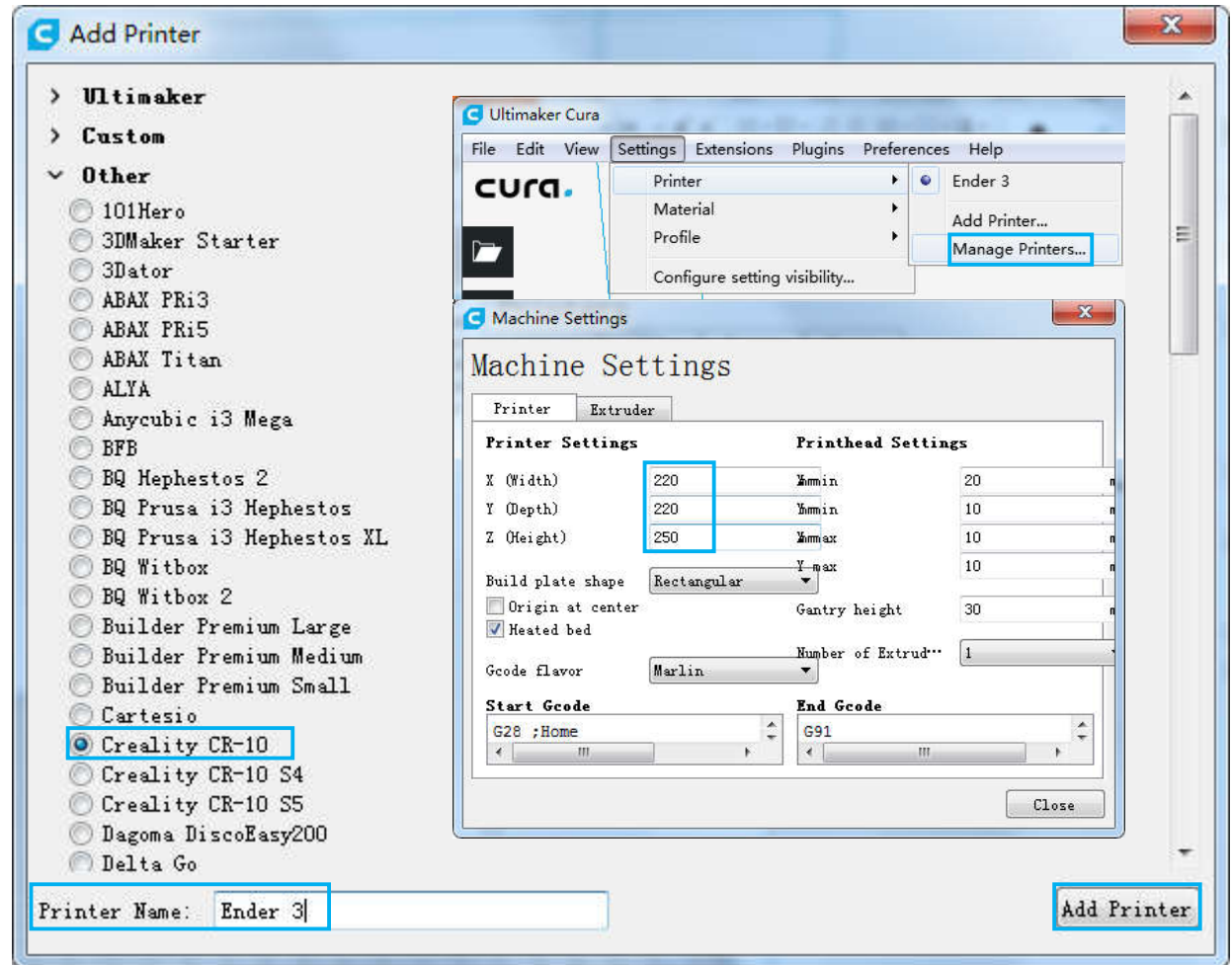

3. Select Other→Creality CR-10→Printer Name: Ender 3→Add Printer.

4. Setting→Printer→Manage Printers...

5. Change Printer Settings to (220,220,250).

6. Preparing to Print

1. Slicing

Insert SD card into computer with Reader.

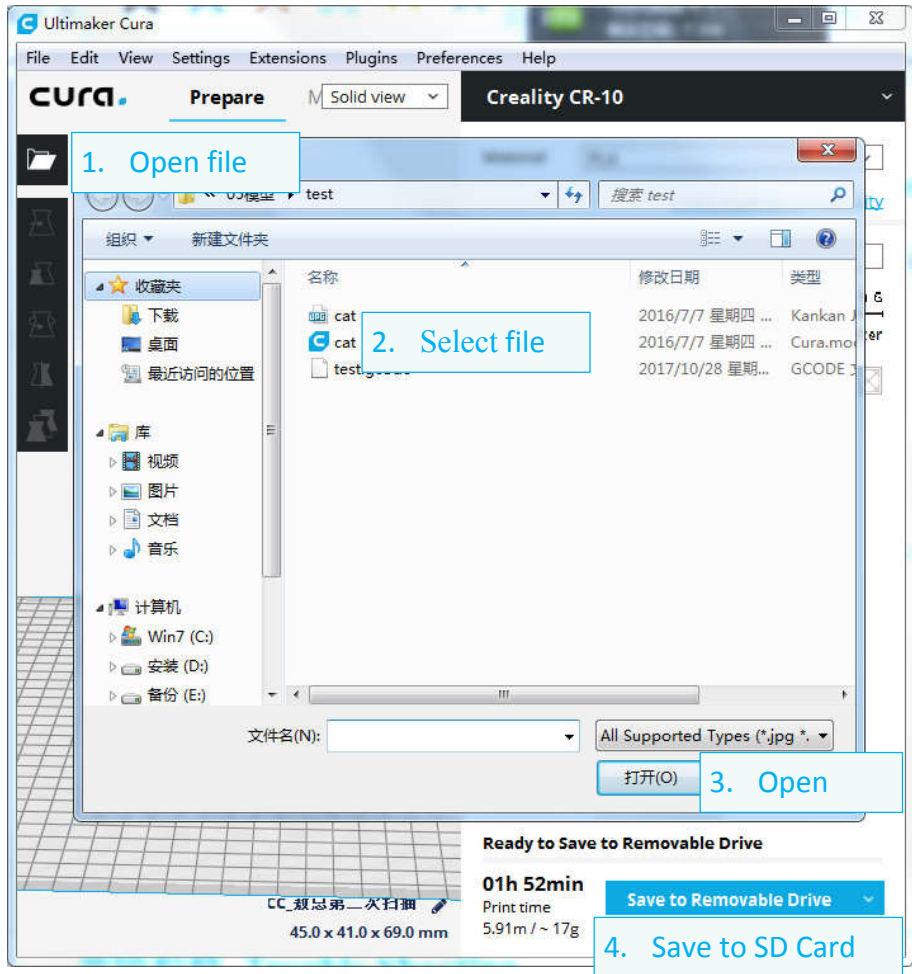

2. Printing



Insert the SD card



Select "Print from SD"

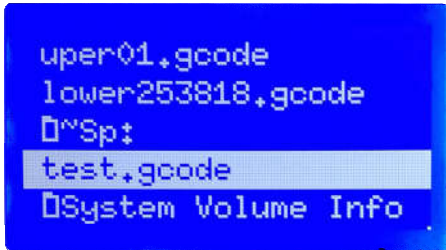

Select the file to be printed

7. Trouble shooting

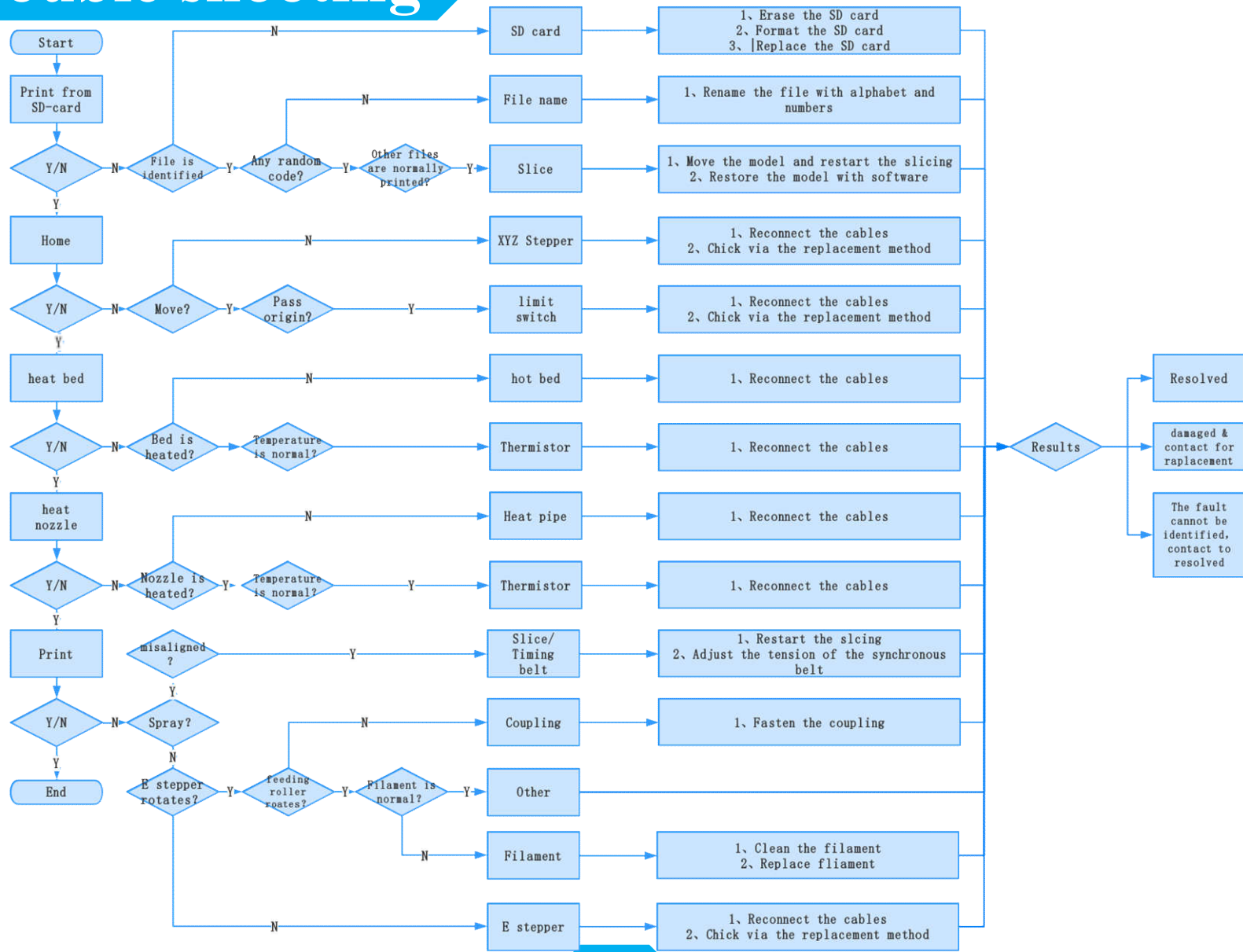

8. Circuit Wiring Diagram

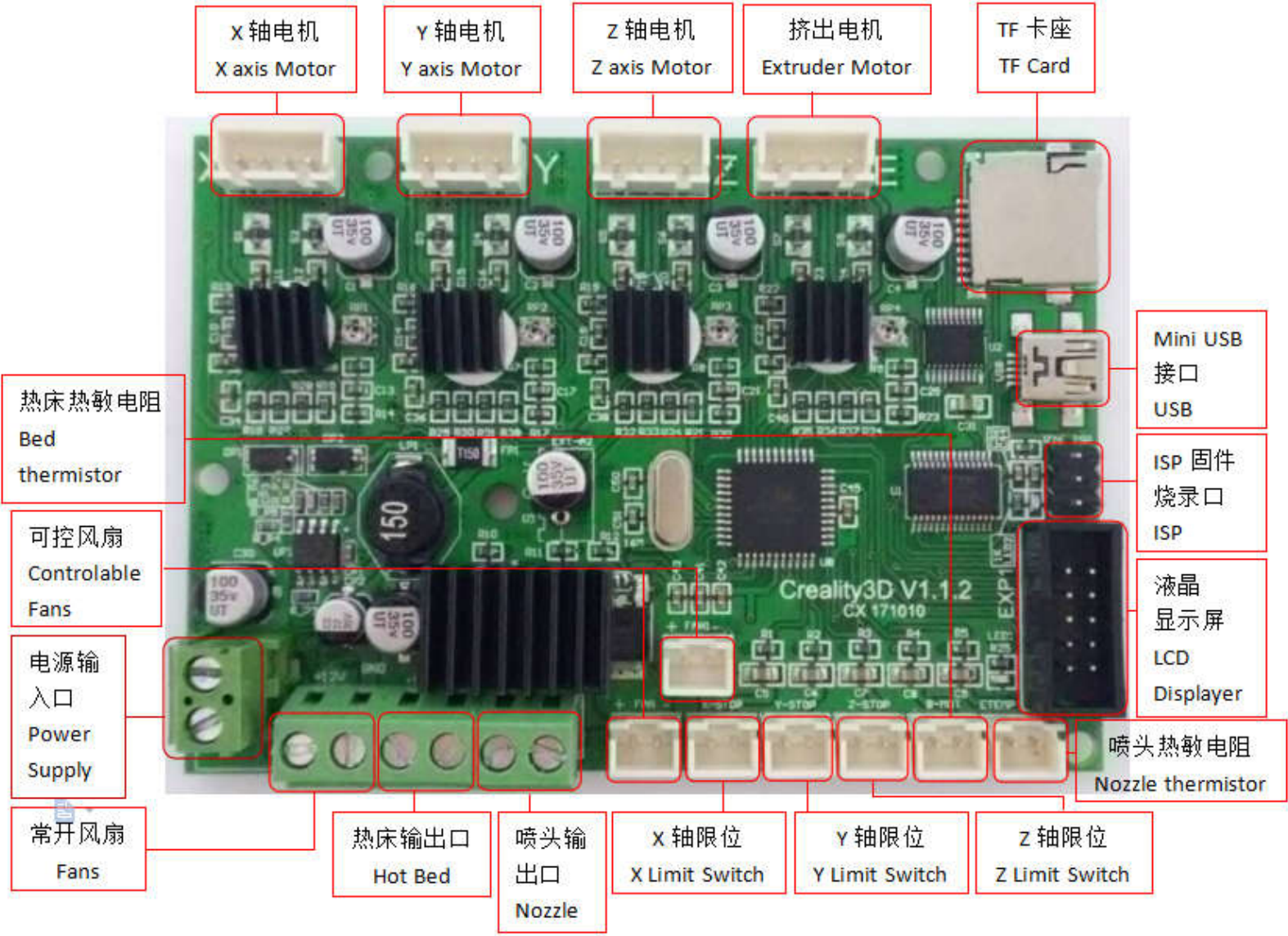



Shenzhen Creality3D Technology CO.,LTD.

Official Website: www.creality3d.com

Company Address: 12F, Building No.3, Jinchengyuan Industrial Area, Huafan Road,
Dalang, Longhua, Shenzhen, Guangdong Province